

ZPU MIĘDZYRZECZ PREINSULATED PIPE SYSTEM

Detection of Pipe Leaks Connection of Pulse Monitoring System in Thermal Utilities

Assembly Manual Principles of Assembly and Servicing

ZAKŁAD PRODUKCYJNO USŁUGOWY
Międzyrzecz
Polskie Rury Preizolowane
Sp. z o. o.
66-300 Międzyrzecz, ul. Zakaszewskiego 4
Phone +095 741 25 26, 742 33 00, 742 00 93
Fax +095 742 18 36, 742 33 02
Version: January 2015

Table of Contents

1	Pulse alarm system (preliminary description)	3
2	Alarm wires embedded in preinsulated pipe units.....	3
3	Parts of alarm system.....	4
3.1	Universal connection box (UPP).....	4
3.2	Grounding	5
3.3	Locating probe resetting terminal (KZL) - white.....	6
3.4	Locating probe (TYPE K).....	6
3.5	Type L-302 failure locating probe (performance capacities)	6
4	Check measurements (prior to assembly of each component)	7
5	Checking circuit continuity	8
6	Checking if wire and steel pipe are not short circuited	8
7	Example of wire connection in zpu międzyczecz sp. Z o. o. Preinsulated pipe and fitting units	10
8	Technical information	14
9	Trade information	14



1 Pulse Alarm System (preliminary description)

ZPU Międzyrzecz Sp. z o. o. preinsulated pipes can be provided with and supplied with a pulse alarm system.

Such an alarm system comprises two bare copper wires 1.5 mm² in diameter, embedded within the PUR foam insulation and laid parallel to the carrier pipe, displaced by 120° with respect to each other (that is at ten to two).

To secure proper connection at assembly, one of the wires is tin plated, which gives the wire a silvery-grey surface, while the other remains in pure copper colour.

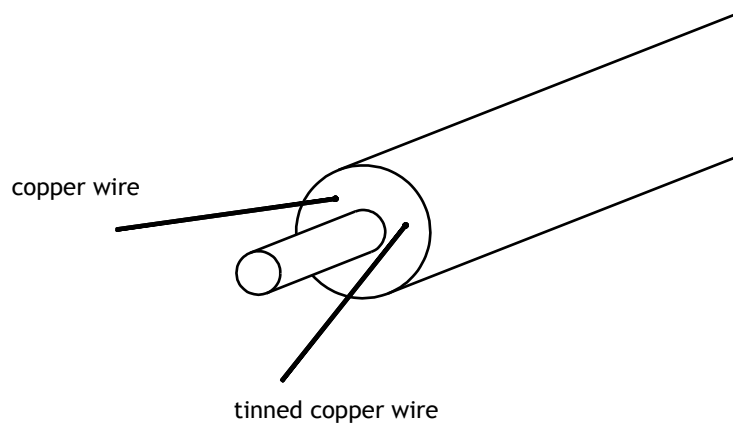

While a pipeline is being assembled, care should be taken so that singular pipe units have their tags facing the heat source, letting the wires be in the upper part of the pipe (so in cross section wires are seen at 1:50 on the clock face); this will allow for the identical wires to be look at their corresponding counterparts.

The tinned wire should be on the right from the heat source. Prior to pipe coupling the wires should be connected by means of clamps, then soldered, checking the quality of the connection.

At the beginning and end of a pipeline are placed universal connection boxes.

On the one pipe end a detecting probe is inlet inside the box by means of a coaxial cable; the opposite pipe end carried a reset terminal on the connection box.

2 Alarm Wires Embedded in Preinsulated Pipe Units

Two monitoring wires are embedded in the PUR insulation layer: one wire is tinned, the other is pure copper set at ten to two on the clock face.

It is important that the arrangement of the monitoring wires is known; this will help locate any failures in the future once the pipe has been put into operation.



Straight Pipe Section

It is recommended that straight pipe sections are laid in such a way that the tinned is on the right from the heat source (co-generating plant).

This will help locate any failures in the future once the pipe has been put into operation.

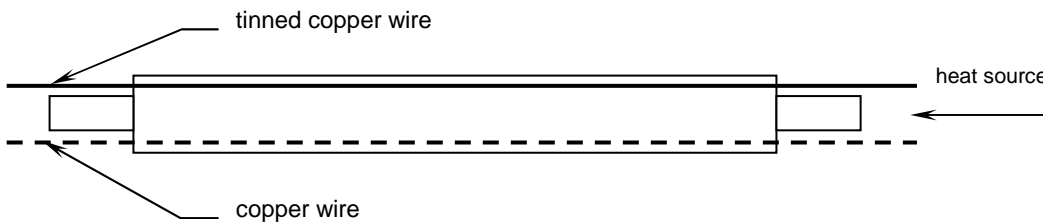

Elbow Section

In horizontal elbows the tinned wire is laid on the outside, while the copper one inside the elbow. Therefore, left elbows have copper wire and tinned wire connected.

Tees

In tees copper wires are in the lateral, the tinned wire goes along the main passage.

Therefore, in all lateral connections a tinned wire has to be connected to a copper wire. It also holds true in right laterals facing the flow direction.

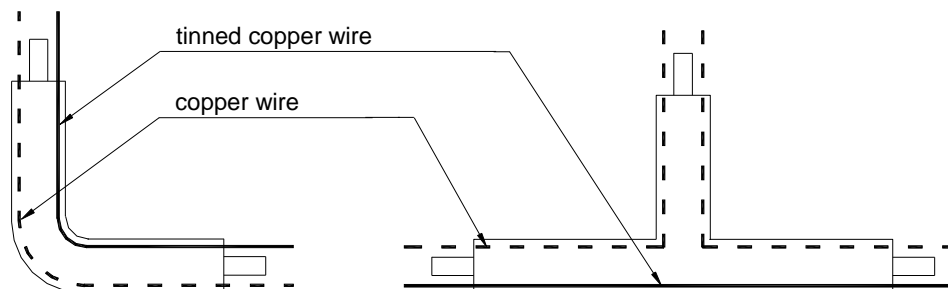

3 Parts of Alarm System

3.1 Universal Connection Box (UPP)

A Universal Connection Box performs a double function in our pulse system:

1. It is used to connect a detecting probe.
2. Together with a reset terminal makes the closing part of the measuring circuit.

In case of a failure within a thermal pipe - thanks to the fact that similar boxes are on both pipe ends - it will be much easier to take measurements of that failure, and locate the failure with greater accuracy.

Boxes are mounted in closed rooms, boiler rooms, basements and chambers.

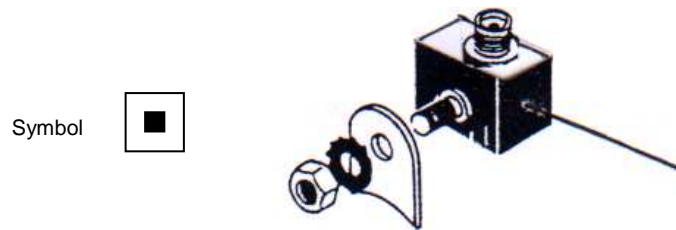

Universal Connection Box (UPP)

3.2 Grounding

Grounding is used to fix a Universal Connection Box to a carrier pipe (made of steel). It is made from a steel metal strip (25×3 mm) 35 mm long, which is welded to a steel carrier pipe in places where the alarm system wiring is output from a preinsulated pipe.

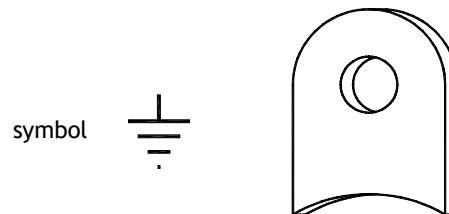

Grounding

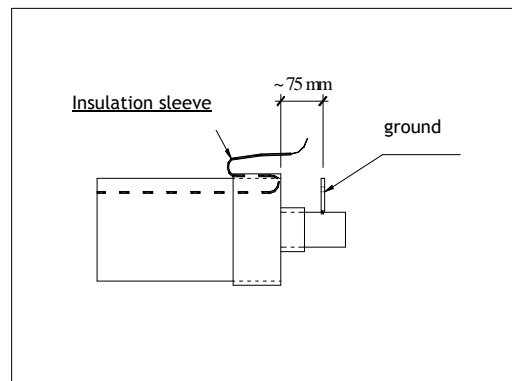

An example of ground terminal fixed (welded to) a steel carrier pipe



3.3 Locating Probe Resetting Terminal (KZL) - white

Locating Probe Resetting Terminal (KZL) is used for testing only purpose to check the failure localizer is working correctly.

During normal day to day operation, there is no need to use the locating probe resetting terminal (KZL) (if the KZL terminal was used to carry out the tests for locator device, KZL terminal should be removed from the universal connection sockets UPP).

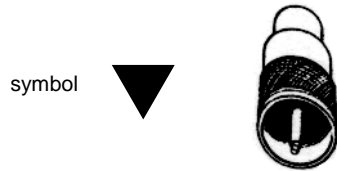

Resetting terminal on a KZL probe

3.4 Locating Probe (Type K)

Locating probe coaxial connecting cables terminated with plugs are supplied in standard lengths (1, 2, 3, 4 and 5 metres).

A locating probe connecting cable (K) is used to connect a failure locating probe and to transmit alarm signals from one pipe onto the next one through Universal Connection Boxes (UPPs).

The manufacturer of the failure locating device recommends using cables with length of 5 m (K-5) for connecting the Locator failure device to the universal junction box.

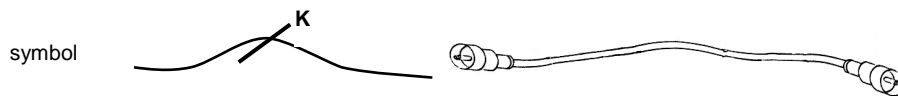

Locating probe coaxial connecting cable (K-1 ÷ K-5)

3.5 Type L-302 Failure Locating Probe (performance capacities)

- It can monitor four independent thermal line sections each up 1000 m long;
- It can differentiate between types of failures (open circuits, short circuit - damping)
- Shows distance from failure to locating probe in metres, simultaneously displaying a faulty channel;
- Pulse is automatically adjusted in relation to utility length;
- Smooth pulse propagation speed adjustment, which allows for our alarm system to be adjusted to a line which incorporated preinsulated units made by other manufacturers;
- Locating accuracy ± 3 m $\pm 1\%$ of utility length;
- Mains 230 V(+10% -15%); 50 Hz ($\pm 5\%$);
- Maximal power consumption 20VA;
- Operating mode: continuous;
- Working temperature $+5^{\circ}\dots+50^{\circ}\text{C}$;
- Tightness grade - IP 44;
- Leak detection threshold $Z_p/Z_1 - 2,5\%$
where: Z_p threshold impedance
 Z_1 pipe wave impedance

Note:

L-302 Failure Locating Probe Operating Manual is in an independent manual.



4 Check Measurements (prior to assembly of each component)

Prior to commencement of assembly works all preinsulated pipes and fittings should be subjected to checks to verify whether alarm wires are complete and have not been damaged in transport or handling. They have to be checked if not broken, cracked and if not in contact with the steel carrier pipe.

Pipe and elbows are checked by connecting pipe or elbow end terminals and taking measurement at the other end.

Control measurements should be performed using any portable measuring device that allows measurement of resistance, loop resistance and loop length of the alarm system (eg. device type LEVR LX-9024).

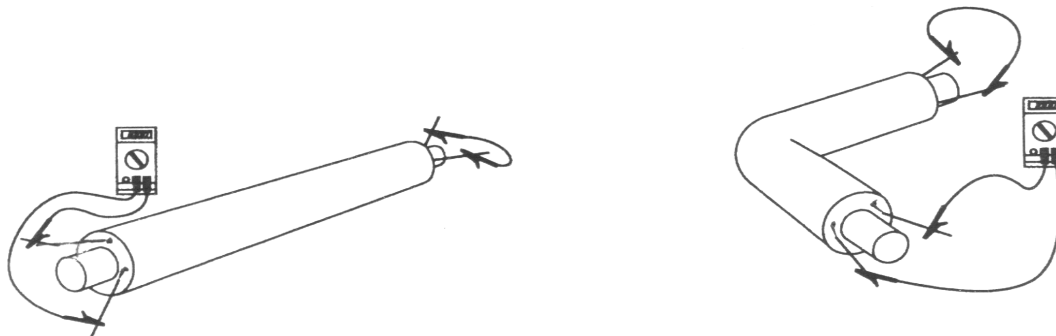

Tees are checked by connecting main passage end terminals and taking measurement at the lateral end.

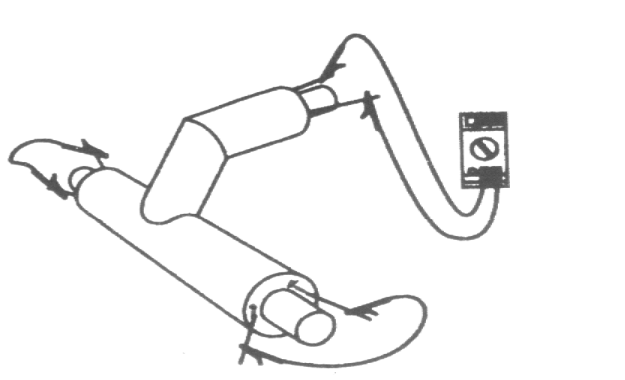



5 Checking Circuit Continuity

Circuit continuity is measured as follows:

Ohmmeter terminals are connected to the copper and tinned wires of the pipe section to be checked.

After confirming that contact between the ohmmeter terminals and the wires is firm and if the wires do not come in contact with the steel carrier pipe.

An approximate resistance reading of the wire should be $1.2 \div 1.5 \Omega$ per each 100 m of the alarm system wire.

Too high a value indicates that the circuit might be broken or that the terminals at the other end are not connected with each other.

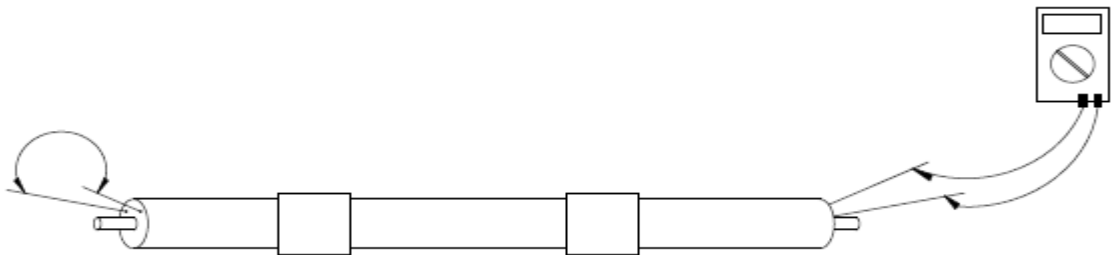

Then a circuit break should be located and removed before further steps are taken.

6 Checking If Wire and Steel Pipe Are Not Short Circuited on a Laid Thermal Network

Check if the wires are not in contact with the steel pipe. Then one of the ohmmeter terminals is connected to the wire (either tinned or copper wire), the other one to a clean spot on the steel pipe.

The ohmmeter reading should show infinity. This means that the insulation between pipe and wire is good (no short circuit).

If a measured resistance is too low, this might be indicative of contact between the steel pipe and wire or that at some place the insulation is damp.

The failure has to be located and repaired.

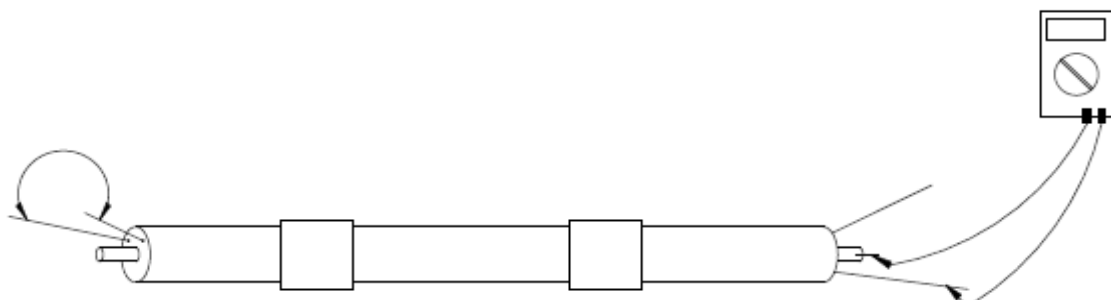



A single preinsulated pipeline element (pipe, elbow, T-piece) can be used in assembling a thermal network if the resistance of its insulation layer is no less than 10 M Ω .

After installation work has been done, completed network's overall total resistance of the insulation layer must be checked.

The total resistances of the insulation layer in the pipe line with a length of 1000 m is correct and suitable for operation if its value is less than 20 k Ω .

Examination of the polyurethane foam insulation for a distribution network should be performed five times between:

- 1) tinned wire and steel carrier pipe;
- 2) copper wire and steel carrier pipe;
- 3) tinned wire and tinned copper wire;
- 4) tinned wire and the diffusion barrier;
- 5) copper wire and diffusion barrier.

Electrical resistance measurements of the polyurethane foam insulation layer for pipes in a distributed network is performed with a constant voltage of 24 V using a portable instrument such as:

-LEVR LX-9024 - range 0÷200 M Ω



7 Example of Wire Connection in ZPU Międzyrzecz Sp. z o.o. Preinsulated Pipe and Fitting Units

thermal utilities made from *ZPU Międzyrzecz Sp. z o.o.* preinsulated pipe and preinsulated fittings where monitoring circuit is embedded.

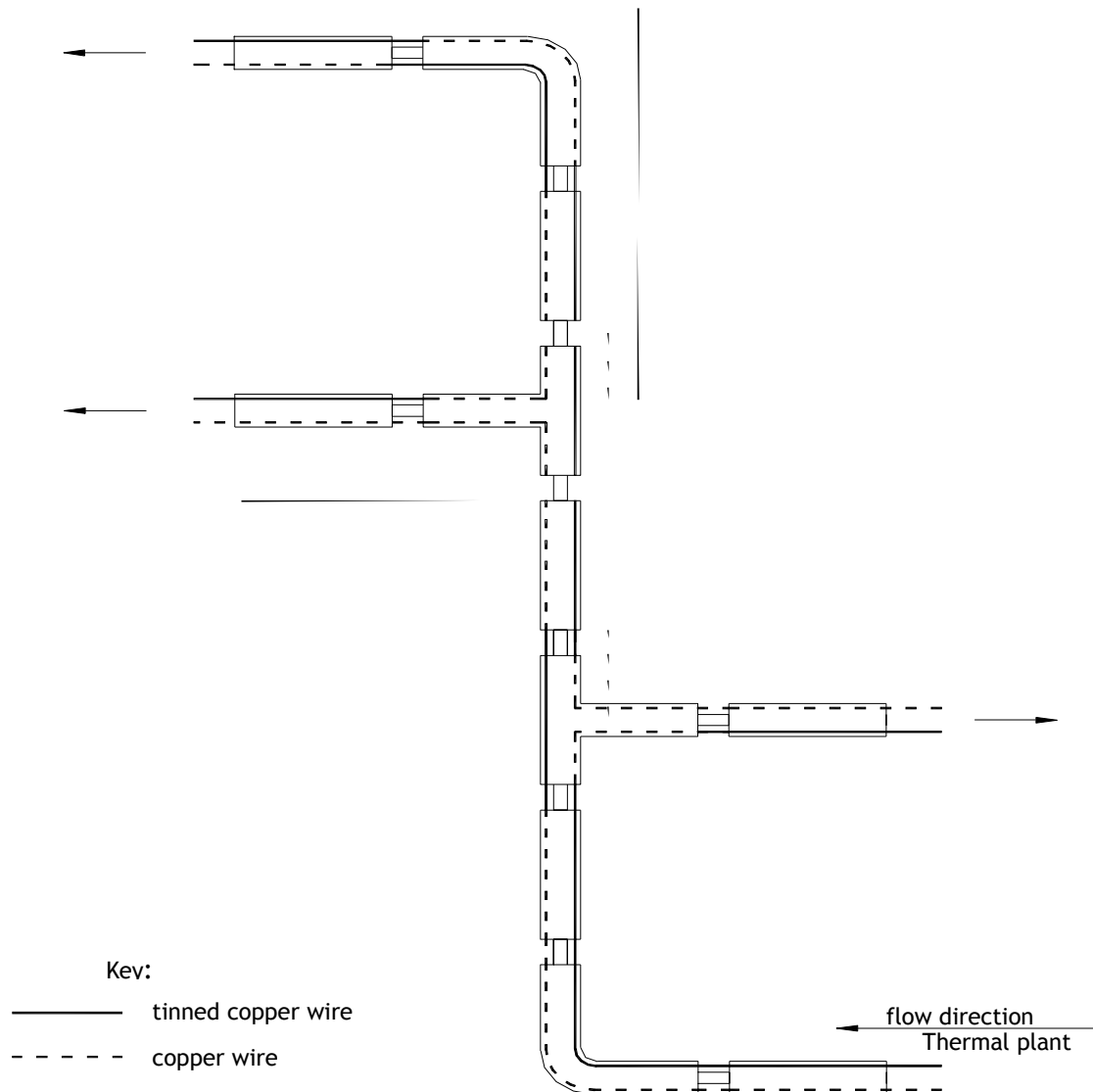

Schematic Diagram Pulse Alarm Installation by ZPU Międzyrzecz Sp. z o. o.

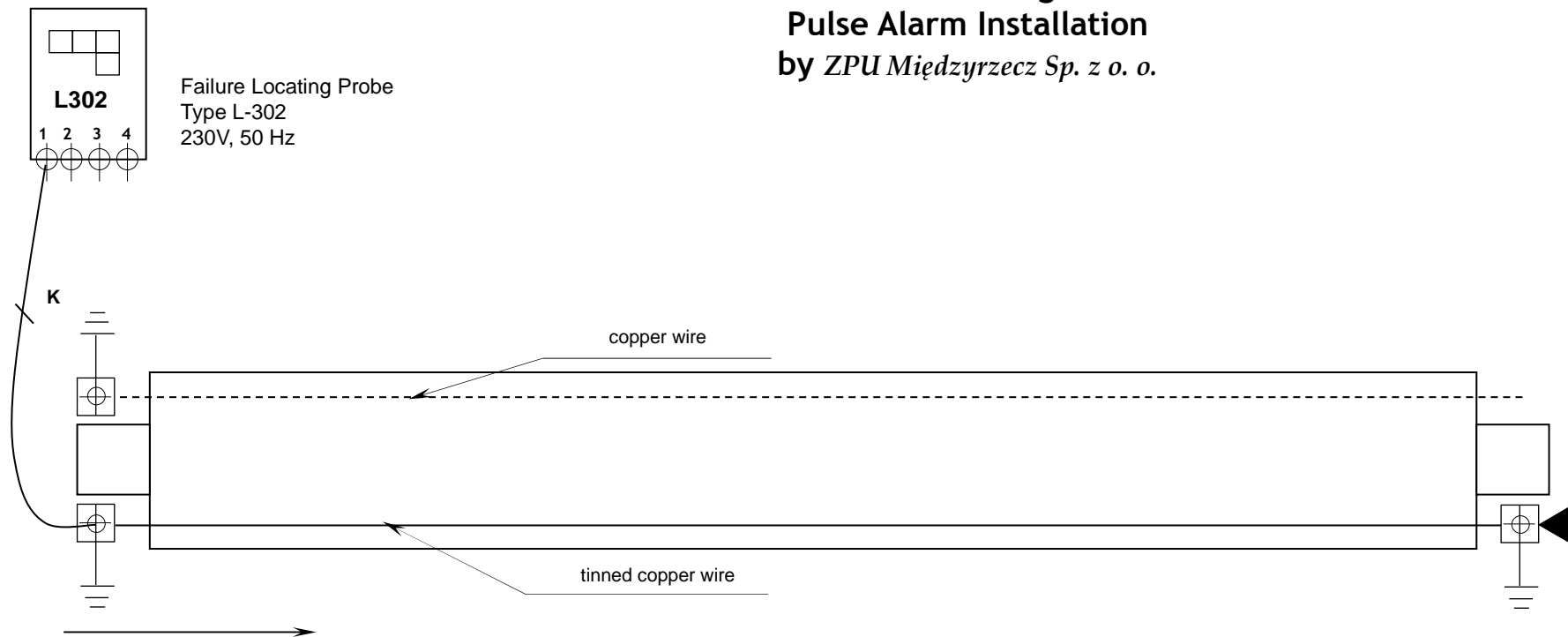

Key:



Universal Connection Box



KZL Resetting terminal



Ground Point (Box Steel Pipe Connection)



Coaxial Cable K-5 (5 m long)

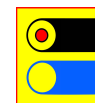

®

**Detection of Pipe Leaks
Connection of Pulse Monitoring System
ZPU Międzyrzecz Sp. z o. o. System**
Phone +48 95 741 25 26; 742 33 00; 742 00 93
fax +48 95 742 33 01; 742 33 02





**Schematic Diagram
Pulse Alarm Installation
by ZPU Miedzyrzecz Sp. z o.o.**

Failure locating probe
Type L-302
230 V; 50 Hz

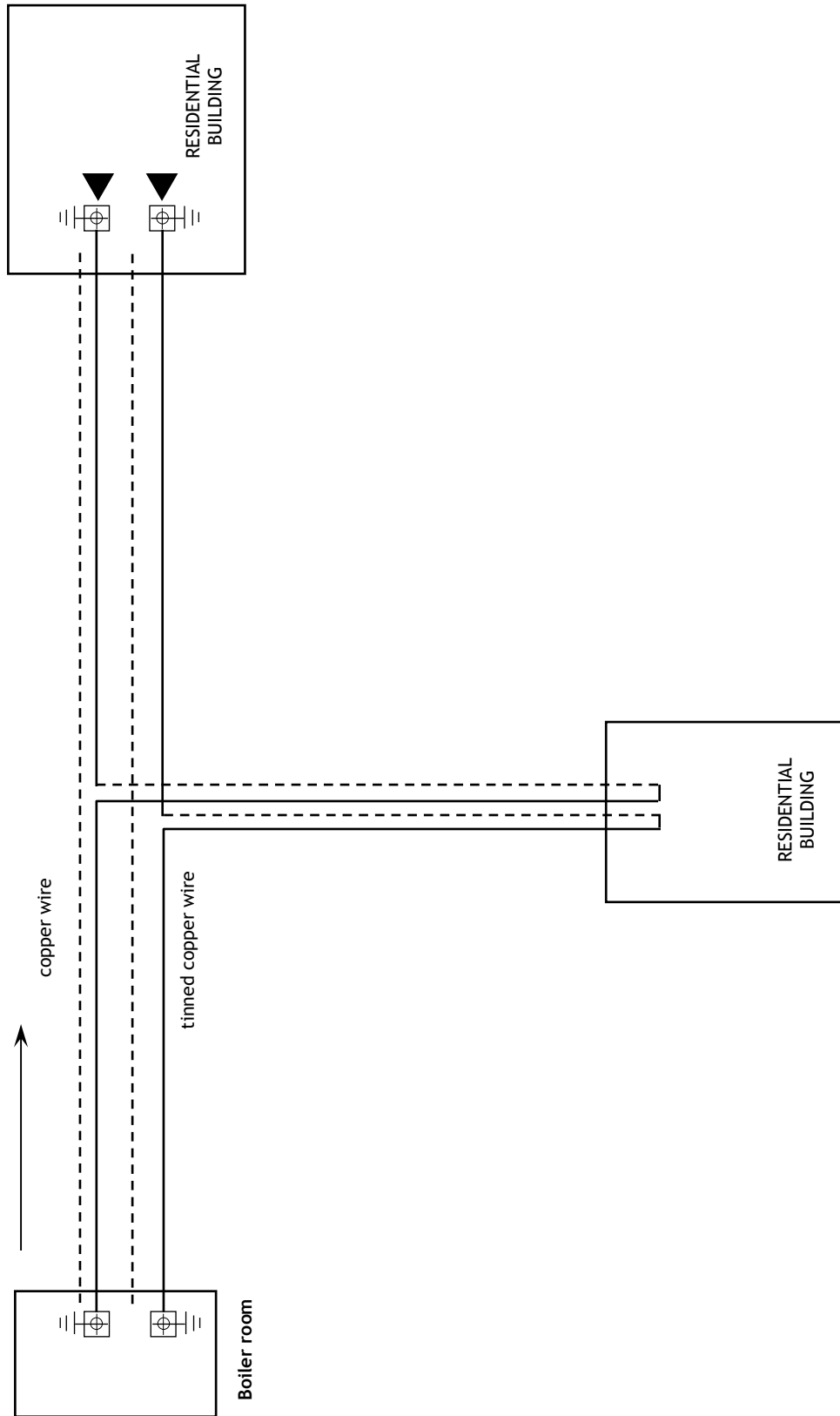
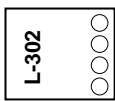



An Example of Schematic Diagram of Pulse Alarm System Installation by ZPU Międzyrzecz Sp. z o.o.

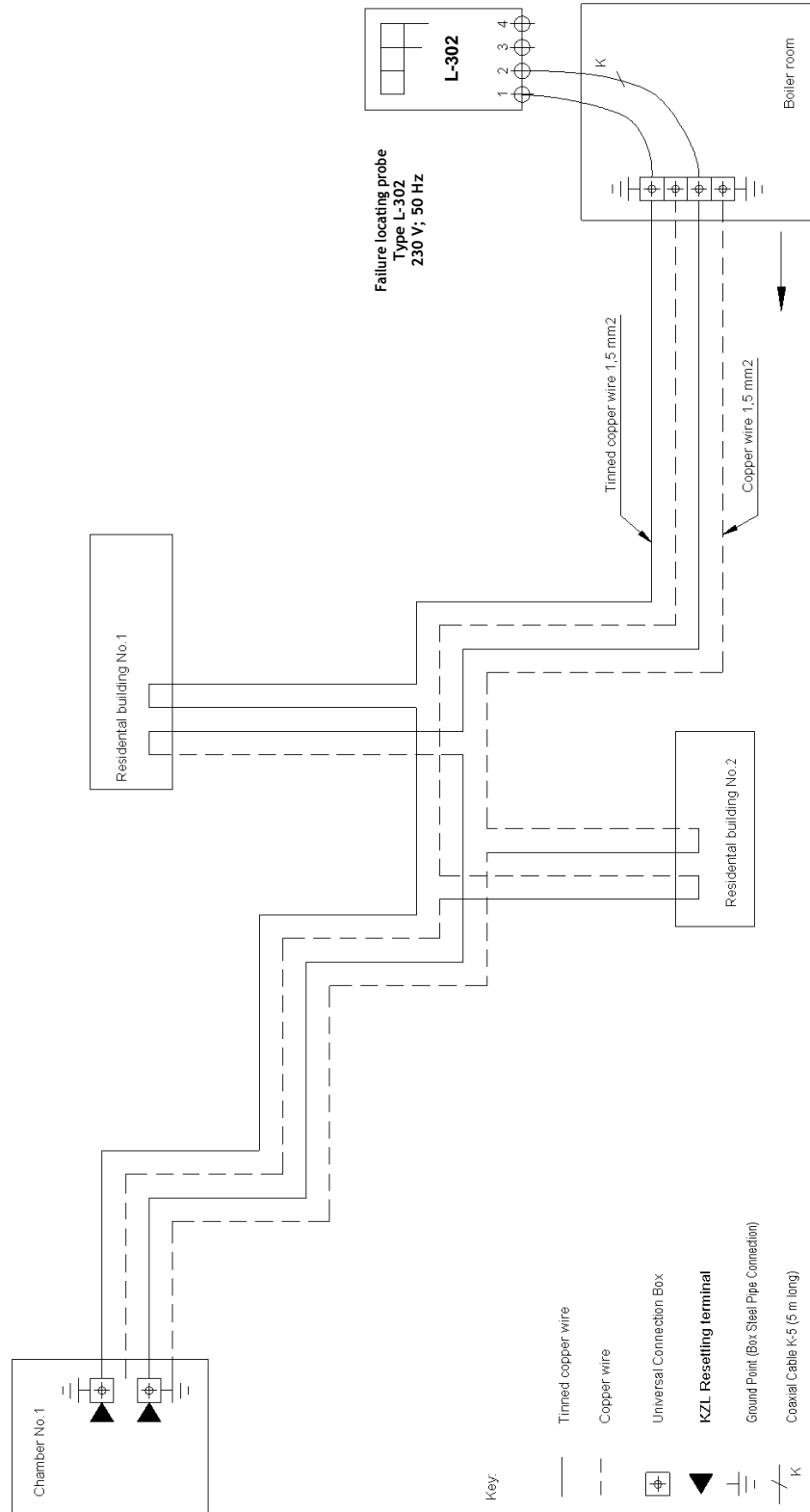



8 Technical Information

The application of preinsulated pipe and fittings has been specified in general above, whilst details referring to design, execution and take over of networks are presented in:

1. Guidelines Static and Design Calculations
ZPU Międzyrzecz Sp. z o. o. System
2. Manual Detection of Pipe Leaks
Connection of Pulse Monitoring System in Thermal Utilities
ZPU Międzyrzecz Sp. z o. o. System
3. Manual Manual of Execution and take Over
ZPU Międzyrzecz Sp. z o. o. System
4. Manual Joint Unit Assembly Insulation and Sealing
ZPU Międzyrzecz Sp. z o. o. System
5. Manual Manual of Steel Pipe Welding
ZPU Międzyrzecz Sp. z o. o. System
6. Manual Steel Pipe Connection Welding Quality Inspection
ZPU Międzyrzecz Sp. z o. o. System
7. Manual DX Joints electrically welded
ZPU Międzyrzecz Sp. z o. o. System
8. Manual DT Type Heat Shrinkable Joints Electrically Welded
ZPU Międzyrzecz Sp. z o. o. System

Note: We convert heat system specifications so that they could meet the requirements of the *ZPU Międzyrzecz Sp. z o. o.* technology solutions.

9 Trade Information

Manufacturer and Seller:

ZAKŁAD PRODUKCYJNO USŁUGOWY

Międzyrzecz
Polskie Rury Preizolowane
Sp. z o. o.,
ul. Zakaszewskiego 4
66-300 Międzyrzecz,

Phones:

Fax +095 742 33 01, 742 33 02

Secretary: +095 741 25 26, 741 00 93, 742 33 00,

Trade Service: +095 742 33 23, 742 33 38

Supplies: +095 742 33 46, 742 33 56

e-mail: zpu@zpum.pl www.zpum.pl

When placing orders please specify carrier pipe steel grade (St 37.0, or P235GH), type of heat insulation, type of polyurethane embedded moisture detection system or its lack, and for pipes specify their length and quote Catalogue Reference Number. If products are to be made-to-order, dimensions have to be agreed separately.